

Automatic Ticket Dispenser

Set Up and Operation Manual



Dispenser Serial Number _____



1005 17th Street
Columbus, NE 68601
Service Dept. 800-795-8251
serv@technikmfg.com
www.technikmfg.com

Set Up and Operation Manual

Table of Contents

<u>SAFETY</u>	3
<u>POWER</u>	3
<u>MOUNTING</u>	4
<u>OPERATING MODES</u>	4
<u>UNPACKING</u>	5
<u>INITIAL POWER-UP</u>	5
<u>DISPENSER SETUP</u>	6
<u>LOAD TICKETS</u>	7-8
<u>REPORTS</u>	9
<u>TICKET OPTIONS</u>	10
<u>MESSAGE OPTIONS</u>	11
<u>SET PRICES</u>	12-13
<u>SET CLOCK</u>	14
<u>TESTING</u>	15
<u>VENDING</u>	16-17
<u>OUT OF ORDER</u>	17
<u>ERROR CODE LIST</u>	18
<u>TROUBLESHOOTING</u>	19
<u>FUSE BLOWN</u>	19
<u>SELF-TESTING COMPONENTS</u>	19
<u>CALLING A SERVICE TECHNICIAN</u>	19
<u>SERIAL NUMBER LOCATIONS</u>	19
<u>PYRAMID BILL ACCEPTOR</u>	20
<u>ACCEPTOR DIAGNOSTICS</u>	20
<u>FRONT BENZEL LIGHTING FLASH CODES</u>	21
<u>INSTALLING THE CASHBOX</u>	22
<u>REMOVAL OF THE LOWER SENSOR PLATE</u>	23
<u>“QUICK RELEASE” TICKET DISPENSE FEATURES</u>	24-27
<u>OPTIONAL THERMAL PRINTER INSTRUCTIONS</u>	28

WARNING!

IMPROPER INSTALLATION, MAINTAINANCE, SERVICE, ADJUSTMENT, ALTERATION, OR USE OF THIS MACHINE CAN RESULT IN PROPERTY DAMAGE, INJURY OR DEATH.

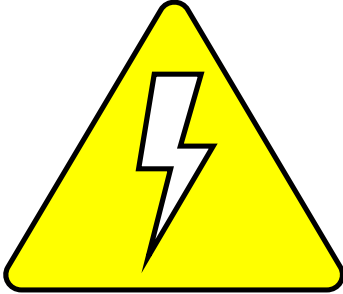

WARNING! TO REDUCE THE RISK OF ELECTRICAL SHOCK, DISCONNECT ALL ELECTRICAL POWER TO THE MACHINE BEFORE SERVICING.

SAFETY

This dispenser was designed using industry accepted safety standards. The power required to operate the dispenser is 110 VAC. *This voltage can be lethal if misused.* The 110 VAC goes to the control panel and power supply and is stepped down to 5 VDC and 12 VDC to operate the computer and dispenser. **The dispenser is to be serviced only by trained personnel.**

POWER

The dispenser operates on standard 110 VAC 60 HZ. It must be plugged into a fused and grounded outlet. The power cord will exit the dispenser from the lower right-hand side.

NOTICE
FOR INDOOR USE ONLY!

MOUNTING

The dispenser needs to be mounted securely to a countertop or wall. If neither is an option, a base plate option is available. Without proper mounting the dispenser may be unstable when the door is open since the weight of the door causes the dispenser to tip forward.

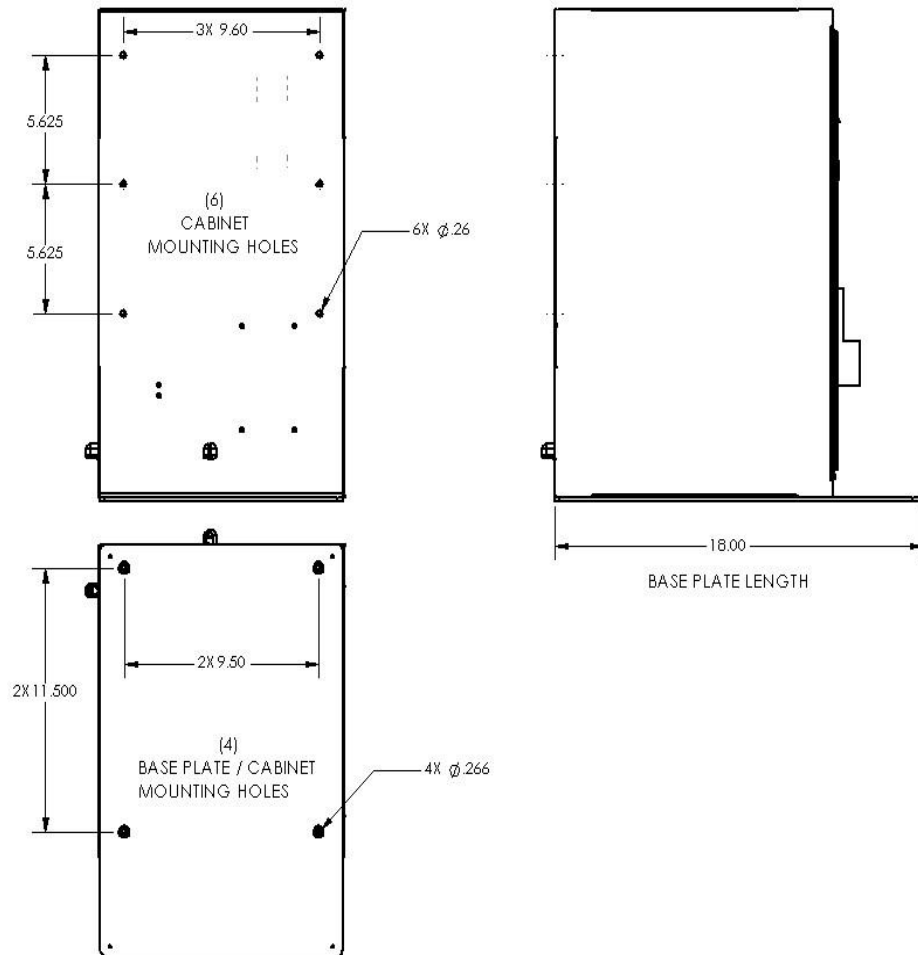

OPERATING MODES

The dispenser has two operating modes which are selected by a pushbutton on the back of the display inside the cabinet. See the following sections for details on using each of these modes.

Vend mode

This is the normal operating mode. In this mode the dispenser accepts payments by cash and dispenses tickets based on the value of the bill inserted into the bill acceptor.

Setup mode

Setup mode allows the operator to set ticket prices, set display messages, view reports and set all other features of the dispenser. All setup functions are performed using the touchscreen on the front door of the dispenser.

UNPACKING

Zip-ties have been used to secure the internal components during shipping and must be removed before powering on the dispenser.

Remove zip-ties from the **Bill Acceptor and Ticket Mechanism.**

WARNING!:: FAILURE TO REMOVE THESE ZIP-TIES WILL CAUSE A MALFUNCTION!

The antenna has been secured to the cabinet for shipping and will need to be re-attached.

Hardware is attached to the antenna wiring inside the cabinet and is ready to be assembled as shown here. →

Use an 11/16” wrench or an adjustable wrench to finish tightening.



INITIAL POWER-UP

Once the dispenser is installed and plugged into a fused and grounded outlet it's ready to be turned on. Open the front door of the dispenser and set the power switch on the control panel to the ON position.

A splash screen will show briefly on the display followed by the normal vending mode screen:

**Jefferson County Fair
Centerville 4-H Club**

Tickets are \$1.00 ea.

**Buy Your Tickets Here!
Prizes Every Hour!**

Sample Vending Screen

At this point the dispenser may be setup using the procedure on page 6.

DISPENSER SETUP

To activate the setup screen, press the SERVICE button on the back of the display inside the cabinet door.

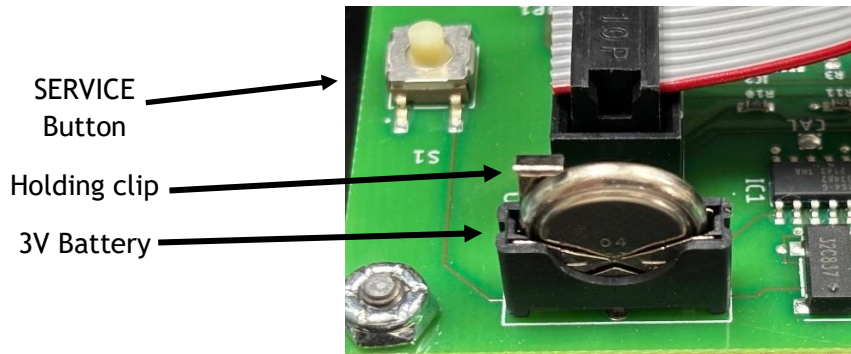

BATTERY & SERVICE Button Location

The Service menu will appear on the screen and all further setup functions may be performed on the touchscreen. Pressing one of the seven buttons will go to a screen that handles that particular function.

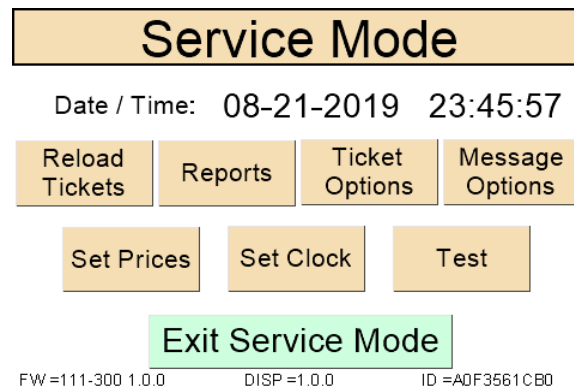

Service Screen

All values on the following setup screens are saved as soon as they are entered so there is no need for a “Save” button on each screen. The only exception is the *Set Clock* screen which includes a “SET” button to make it easy to exactly synchronize the clock if desired.

When all setup operations are complete press the “Exit Service Mode” button for all updates to take effect, and to return to normal vending mode.

It is recommended that the dispenser **ONLY** be turned off when in **vending** mode. This is to ensure that all service settings have been saved before turning off the power.

A 3-volt battery (pictured above) is used to power the memory when the kiosk is unplugged, or the power goes out. When replacing, verify the positive end is facing the service button and the battery is seated under the holding clip.

LOAD TICKETS

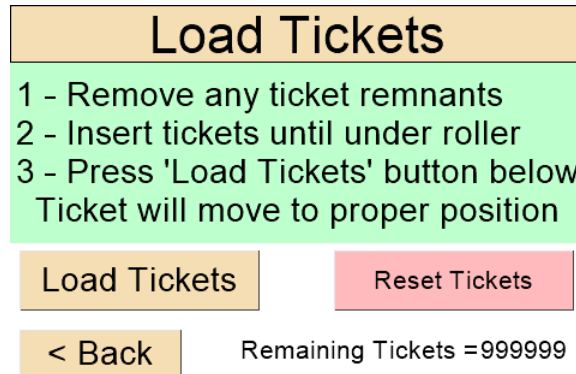

Load Tickets Screen

Follow the instructions shown on the screen to place the new tickets under the feed roller of the ticket dispenser. **DO NOT EXTEND TICKETS BEYOND THE FRONT SLOT ON THE DISPENSER DOOR.** Press the “Load Tickets” button and the tickets will advance until they’re properly placed in the dispenser. If done properly no tickets should extend outside the dispenser slot and all tickets loaded will be accounted for properly.

The “Reset Tickets” button can be used to set the “Remaining Tickets” count back to the “Full Ticket Count” level set in the *Ticket Options* screen shown on page 10.

LOADING FANFOLD TICKETS



Place fanfold tickets into the hopper as shown.

LOADING ROLLED TICKETS:

NOTE: Largest roll size = 8.5" diameter. Smallest core size = 0.75" diameter.

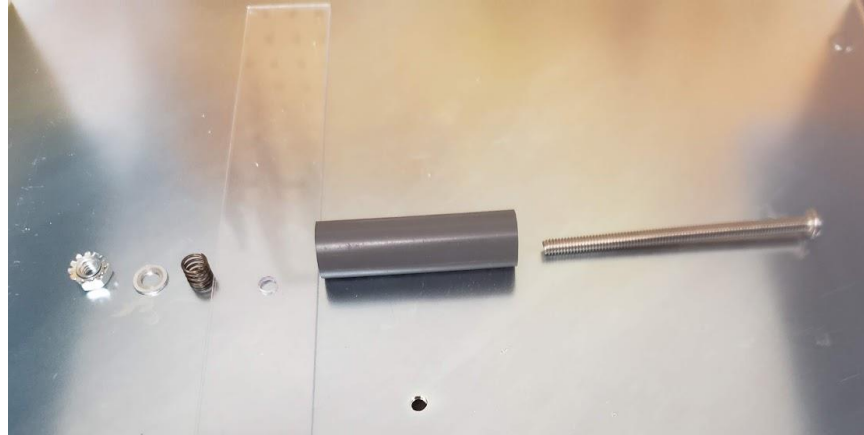

The rolled ticket mounting kit consists of the parts shown above. Install the screw into the threaded hole in the side of the hopper.

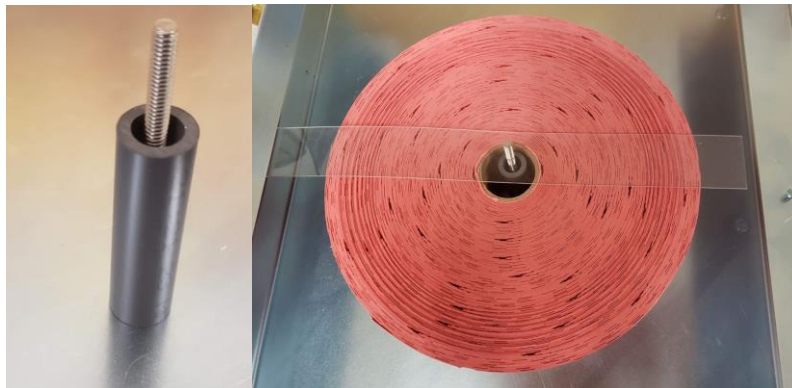

Slip the plastic roller over the screw. Hang the ticket roll over the plastic roller and place the plastic guard over the threaded end of the screw.



Install the spring, washer and nut on the screw to hold the plastic guard in place.

DO NOT OVER-TIGHTEN THE NUT!

Spring must NOT be fully compressed. The ticket roll may bind, or the plastic guard may break.

REPORTS

Show Reports		
Jefferson Co. Fair		
	Lifetime	Period
Credits:	15974.00	1629.00
Credit Erased:	53.00	2.00
Tickets Sold:	15974	1629
Available:		9428
Start Date:	08/21/19	09/10/19
< Back		Reset Period

Show Reports Screen

Reports of cash received and tickets sold can be displayed on the Show Reports screen. The green box displays lifetime cash (credits) received, tickets sold and the start date of the reporting period. These totals are non-resettable and will be stored permanently in the memory of the dispenser. The red box displays the same information but is resettable when desired.

Credits Credits received by the bill acceptor (in US dollars)

Credit Erased Credits representing money which has been inserted in the bill acceptor but for which no tickets were dispensed. This may happen if a customer inserts a bill which is larger than an even multiple of the ticket value and then did not insert any more money to buy another ticket. For example, if tickets are priced at \$2 and a customer inserts a \$5 bill the dispenser will vend 2 tickets and wait with \$1 credit remaining, waiting for the customer to insert another \$1 to vend another ticket. If the customer walks away the \$1 remaining credit will clear after a 6-minute delay and be recorded here.

Tickets Sold The total number of tickets sold for the period.

Available The number of tickets still remaining in the dispenser. This is a calculated value based on subtracting the number of tickets sold from the "Full Ticket Count" value (*Ticket Options* screen). For this value to be correct the "Remaining Tickets" must be reset when new tickets are reloaded. The dispenser has no mechanical means of counting the actual tickets remaining in the dispenser hopper.

Start Date The date the period began. The Lifetime start date will not change. The Period start date will reset to the most recent date the period was reset.

The Period reports can be reset by pressing the "Reset Period" button.

TICKET OPTIONS

Ticket Options

Location Name: Jefferson Co. Fair

Full Ticket Count: 10000

LowTicket Count: 200

On Service button go to load tickets directly

On load tickets reset available tickets counter

On load tickets reset period counts

< Back

Ticket Options Screen

Press on any of the blue fields to edit values in those fields.

Location Name: Provide a brief description of the dispenser’s location. This value is displayed on the **Reports** screen.

Full Ticket Count: The number of tickets which are loaded each time the dispenser is reloaded. This value is used to calculate the Available tickets value on the **Reports** screen. This value must be set BEFORE resetting the remaining Tickets on the **Load Tickets** screen. This value will usually only need to be set once unless the number of tickets in a new package of tickets changes.

Low Ticket Count: When the dispenser calculates that the remaining tickets are approaching this level it will display a discreet “low ticket” warning in the lower right corner the main vend screen. If the available number of tickets is below this level after a sale completes the dispenser will display an **Out of Order** message and wait to be reloaded.

Three checkboxes are also available to set advanced options.

CAUTION: USE THESE OPTIONS WITH CARE as data loss may result if used incorrectly. We recommend you become completely familiar with the dispenser’s operation before activating these options.

On Service button go to Load Tickets directly: If checked the dispenser will go directly to the **Load Tickets** screen when the SERVICE button is pressed. This is handy since loading tickets is the most-used function of the SERVICE button.

On Load Tickets reset available tickets counter: When checked the dispenser will automatically reset the “Remaining Tickets” count whenever the **Load Tickets** screen appears, saving the need to manually reset the Remaining Tickets after each reload. The “Remaining Tickets” count is displayed on the **Load Tickets** screen and is used to calculate the number of tickets remaining after each sale.

On Load Tickets reset period counts: This option will reset the Period count values whenever the **Load Tickets** screen appears, saving the need to switch to the **Reports** screen and resetting the period count after each reload.

MESSAGE OPTIONS

Vend Screen Messages

Line 1: Jefferson County Fair
Line 2: Centerville 4-H Club
Tickets are \$X.00 each
Line 3: Buy Your Tickets Here!
Line 4: Prizes Every Hour!

< Back

Messages Options Screen

This screen allows setting the messages which are displayed on the normal vending screen. Up to four lines of text may be entered that display above and below the ticket price as previewed on this screen and any lines that are not needed can be left blank. Pressing on one of the blue text boxes will bring up a keyboard screen that allows entering new text for that message.

Clear																Cancel	
q	w	e	r	t	y	u	i	o	p	DEL							
TB	a	s	d	f	g	h	j	k	l	OK							
CAPS	z	x	c	v	b	n	m	,	.	;							
123	(SPACE)	?						

Keyboard Screen

SET PRICES

SCREEN SHOWN WITH A CREDIT CARD READER

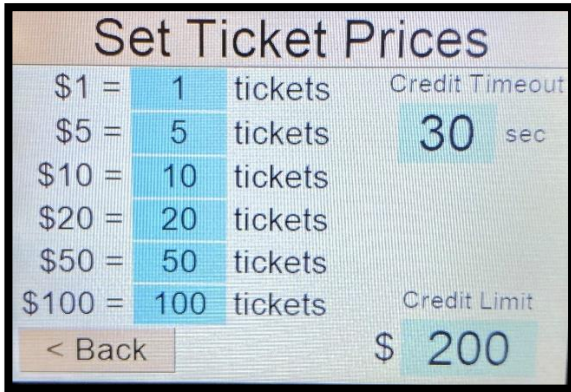

SCREEN SHOWN WITH BA OR CC WITH BA

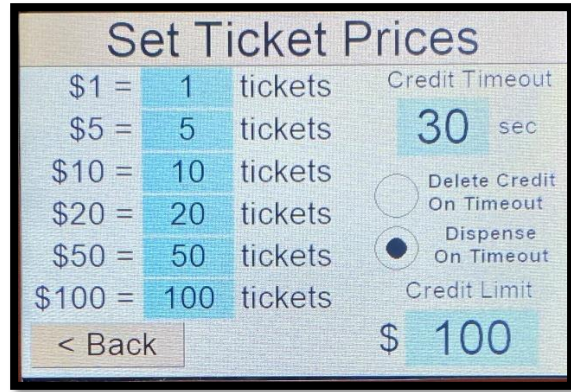

If the machine is equipped with a credit card reader only, you will see the screen on the left. A machine with a bill acceptor, or a BA with a cc reader, will show the screen on the right. This screen allows the option to delete the BA credits on timeout or dispense credits on timeout.

Price per Ticket:

The price for each ticket can be set to any value from \$0.01 to \$999.99. Press on the blue field containing the ticket price to bring up a keypad screen that allows entering the ticket price:

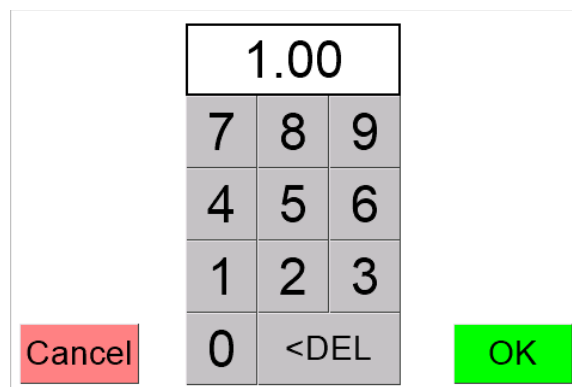

Keypad Screen

The keypad will always require two decimal places on each price so enter a full-dollar value by pressing two zeros after the full dollar amount, i.e. enter \$1.00 by pressing 1, 0, 0. Press OK to enter the new value or Cancel to leave the original value unchanged.

Quantity Discount Pricing:

Tickets may be sold at a quantity discount by entering values into these two fields. If used, the Quantity Discount Pricing values may override the individual ticket price when vending tickets. Use this feature with care as it's necessary to consider the vending method of the dispenser, the base ticket price and the limits of accepting fixed values of cash when setting discount levels.

SET PRICES CONTINUED

The discount price must be a multiple of the bill value the bill acceptor is programmed for (\$1, 5\$, \$10, \$20, \$50 and \$100).

If a bill of smaller value than the discount price is inserted, the dispenser will attempt to vend the number of tickets permissible for that bill based on the “Price per Ticket” entered.

Remember that each bill inserted is considered a single transaction and the dispenser will not wait for another bill if it's possible to vend tickets based on the amount inserted. Only in cases where the amount inserted is not sufficient to sell a ticket will it wait for another bill, and then only for the set Credit Timeout period (see below).

Here are some common scenarios that would make sense:

Base ticket price: \$1.00
Qty. discount price: \$5.00
Qty. discount tickets: 6

This will work as the dispenser will vend one ticket if a \$1 bill is inserted but will vend 6 tickets if a \$5 bill is inserted. Since the dispenser vends on a bill-by-bill basis it is NOT possible to insert five individual \$1 bills and receive 6 tickets. If a \$10 bill is inserted the dispenser will vend 12 tickets and so on for \$20, \$50 and \$100 bills.

Base ticket price: \$0.25
Qty. discount price: \$1.00
Qty. discount tickets: 5

This will also work as the dispenser will vend five tickets if a \$1 bill is inserted, 25 tickets for a \$5 bill and so on. It will never vend just four tickets unless the Quantity Discount Pricing feature is disabled by setting its values to 0.

Credit Timeout:

If a customer inserts more money than needed to buy a ticket (e.g. a \$5 bill to buy two \$2 tickets) the dispenser will stop after issuing the maximum number of tickets possible for that transaction and will display the remaining amount of credit available on the display. If the customer inserts more cash at that point the credits will increase until another ticket(s) may be dispensed. If the customer walks away with credit remaining on the display the dispenser will wait the number of seconds set here before erasing the remaining credit and returning to its idle state. Any credits that remain at the end of the timeout period are recorded in the “Credit Erased” fields of the **Reports** screen.

SET CLOCK

Set Date and Time					
Mo	Day	Year	Hour	Min	
^	^	^	^	^	
6 - 10 - 2020			15:20		
v	v	v	v	v	
< Back			SET		

Set Clock Screen

The dispenser contains an internal battery backed up clock which may need to be reset if the battery is removed or if the dispenser is serviced. The clock is used to keep track of the reporting period dates.

Set the date and time (24 hour format) by using the up and down arrow buttons to set the correct values and then pressing the “SET” button.

TESTING

Test	
Bill Acceptor	Ticket Dispenser
Credits: 0.00 Status: Offline	Ticket: Present Motor: OFF
Enable B.A.	Ticket Out
< Back	

Test Screen

Some basic dispenser functions may be tested using the *Test* screen.

Bill Acceptor testing:

The bill acceptor may be tested to see if it's communicating properly with the dispenser controller. Pressing the "Enable B.A." button should cause the bill acceptor to go online and its blue lights should begin to flash. Once enabled, bills may be inserted and a running total of cash inserted will display in the green box above the "Enable/Disable B.A." button. These credit values will NOT be recorded in the internal reports.

Ticket Dispenser testing:

Pressing the "Ticket Out" button will run the dispenser for as long as the button is held down. As ticket notches pass by the notch sensor in the dispenser the "Ticket: Present/Absent" message in the yellow box will change briefly. Ticket notches will also cause the red light on the side of the dispenser to flash as they pass. Tickets dispensed in Test mode will NOT be recorded in the internal reports.

VENDING

When the power is turned on or the “Exit Service Mode” button is pressed on the *Service* screen the dispenser will enter Vend mode. When the dispenser is operating normally the following screen will be displayed:

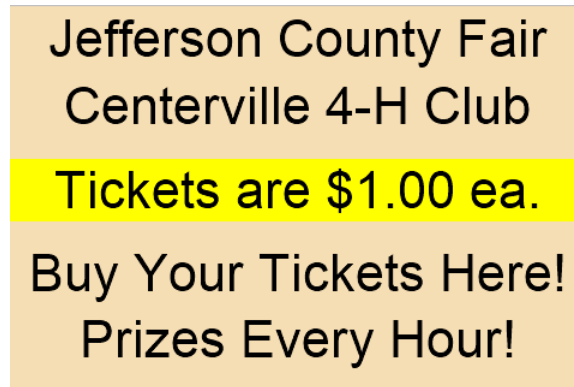

Idle Screen in Vend Mode

At this point the bill acceptor will be enabled (blue lights on) and customers may insert cash to make their purchase. When cash is inserted into the bill acceptor, the display shows the credit screen, which displays the amount of money accepted and the number of tickets to be dispensed. Tickets will not dispense until the dispense button is pushed.

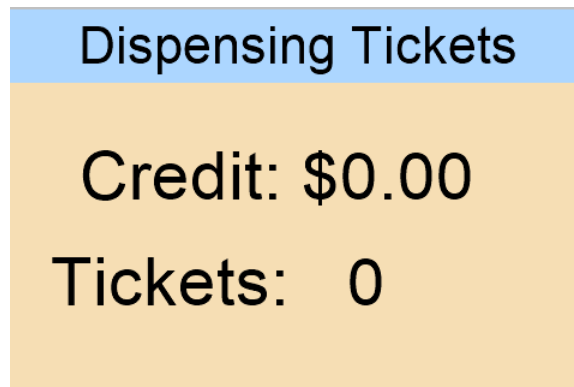

Vending Screen

The bill acceptor is disabled during the dispense cycle and will not accept money while tickets are dispensing. After the dispense cycle completes, the screen will switch back to the idle message and the bill acceptor will be re-enabled.

If the initial bill inserted is insufficient to purchase even one ticket the dispenser will show the amount collected and wait for another bill to collect sufficient credit for a sale.

If sufficient funds are not inserted within the credit timeout period, the remaining credit is erased and the dispenser goes back to an idle state waiting for the next transaction.

VENDING CONTINUED

If one or more tickets are dispensed but the pricing is set such that there are credits left over after the dispense (e.g. \$2 tickets with a \$5 bill inserted) it will again wait for more money before timing out after the credit timeout period (see above). Any credits that remain at the end of the timeout period are recorded in the “Credit Erased” fields of the *Reports* screen.

OUT OF ORDER

If the dispenser detects an error while dispensing tickets (such as a jam) or if the remaining ticket level drops below the “Low Ticket Count” value on the *Ticket Options* screen (see above) it will display the Out of Order screen:



A number will be displayed in the lower-right corner of the screen indicating the particular error that occurred. At this point the dispenser will no longer accept money or dispense tickets and must be put into Service mode to clear the problem. See page 16 for error code definitions.



One of the following error codes will be displayed in the lower-right corner of the screen:

Dispenser Empty	1	Dispenser is empty
Dispense Error	2	Possible ticket Jam
NVRAM Error	3	Part number and/or version number does not match
Display Comm Error	4	Can't communicate with the display
Display Firmware Error	5	Display firmware version miss match
BA Error	6	Cannot communicate with the BA
SD Card Mount Error	7	SD card installed incorrectly
SD Card Missing Error	8	No SD card detected
SD Card Too Small Error	9	SD card does not have enough memory
SD Card Read Write Error	10	SD card may be damaged
SD Card Full Error	11	SD card memory is full
SD Card File Missing Error	12	SD card file not found
Wi-Fi Connection Error	13	Unable to connect with Wi-Fi
Network Time Error	14	Website connection has taken too long
I2C Error (board)	15	UART communications error
BA Full Error	16	The BA Stacker is full
BA Jammed Error	17	The BA is jammed
BA Failure Error	18	The BA is in a failure mode
BA Cassette Missing	19	The BA's Cassette/Stacker is missing / not connected
BA Out of Service	20	The BA is out of service
VPOS Not Paired	21	Unable to pair with VPOS
Unknown Error	22	Unknown Problem

TROUBLESHOOTING

FUSE BLOWN

If the dispenser shuts down and nothing works, check the fuse on the control panel next to the power switch. The dispenser uses a 6¼-amp AGC fuse.

SELF-TESTING COMPONENTS

The bill acceptor and ticket dispenser mechanism may be tested using the *Test* screen from the *Service* menu. See p. 13 above.

CALLING A SERVICE TECHNICIAN

When calling for service PLEASE HAVE YOUR DISPENSER'S **SERIAL NUMBER READY**.

Call
402-564-3191 or **800-795-8251**
for the TMI service department.

SERIAL NUMBER LOCATIONS

The serial number is located on the front of this manual and on the inside of the main cabinet door below the door lock.

PYRAMID BILL ACCEPTOR

ACCEPTOR DIAGNOSTICS

Use the Diagnostic Pushbutton on the side of the acceptor (toward the rear) as shown.

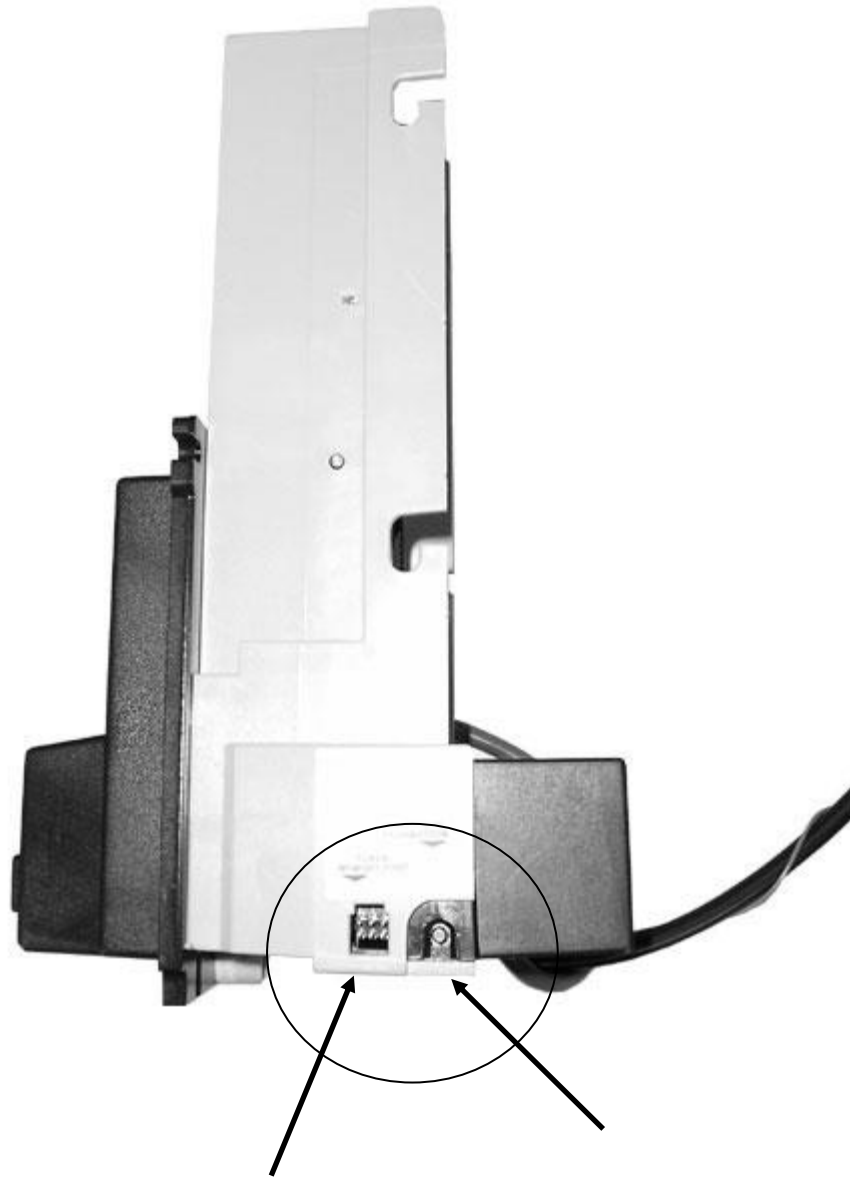

Flash Memory Connector

Diagnostic Push Button

FRONT BEZEL LIGHTING FLASH CODES

The flash codes shown correspond to the Apex bill acceptor error. The acceptor will flash the error code then wait 3 seconds and flash it again.

FLASHING CODE	MEANING OF FLASHING CODE	CORRECTIVE ACTION
LEDs always OFF	The acceptor has no power.	Check that power has been applied.
LEDs always ON	No error exists - acceptor is OK.	None.
1 Flash	Something is in the bill path	Remove the cassette and Lower Sensor Plate to inspect for foreign objects. Clean if necessary.
2 Flashes	Something is obstructing the stacker.	Remove the cassette and Lower Sensor Plate to inspect for foreign objects. Clean if necessary.
3 Flashes	The cassette is full of currency.	Remove the cassette and empty it.
4 Flashes	The cassette has been removed	Replace the cassette.
5 Flashes	The acceptor is defective	Replace the acceptor.
6 Flashes	The acceptor is not enabled	Verify that the host has enabled the acceptor.
10 Flashes	Configuration Mode has been entered.	Configuration Card must be inserted into the acceptor or cycle power to the acceptor to exit this mode. See Configuration Section for details.

REMOVING THE CASHBOX

To remove the stacker, push back the Cashbox Latch toward the front of the acceptor. Then pull the Cashbox upward, and then pull back to remove.

Cashbox Latch

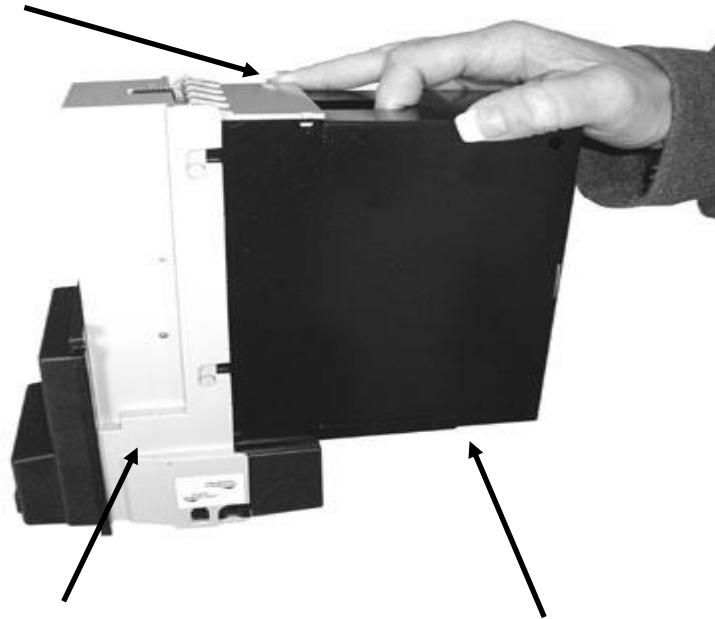

Main housing

Cashbox

INSTALLING THE CASHBOX

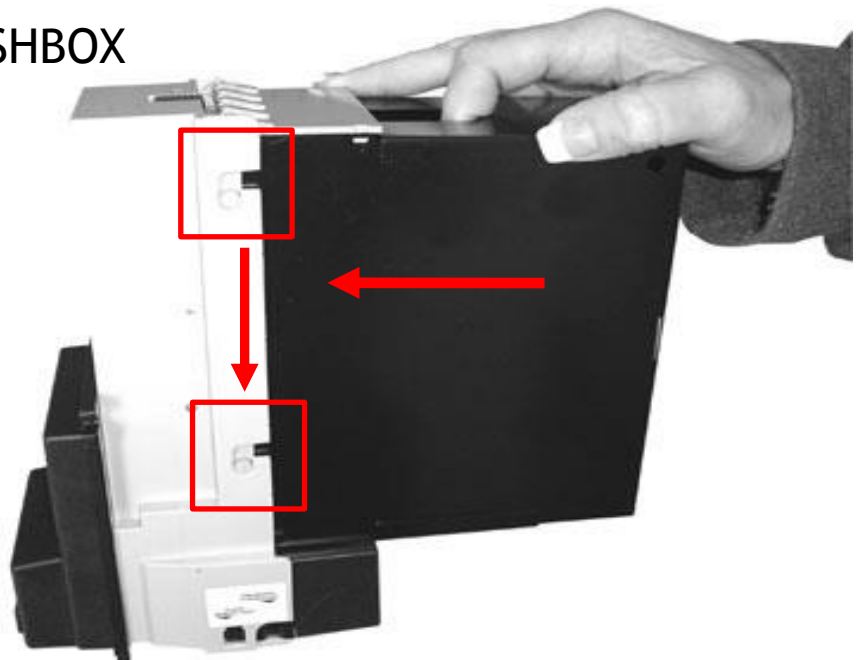

Note: When installing the cashbox make sure the tabs are pushed forward into the slots on the main housing. Then push down, making sure they click into place. If the cashbox is not properly installed the bill acceptor will not function.

REMOVAL OF THE LOWER SENSOR PLATE

Removal of the Lower Sensor Plate is done by pressing the locking tab in and pulling the plate back. **NOTE:** Before removing the Lower Sensor Plate, make sure you unplug the 18-pin connector from the other side of the bill acceptor. It is not shown in the picture.

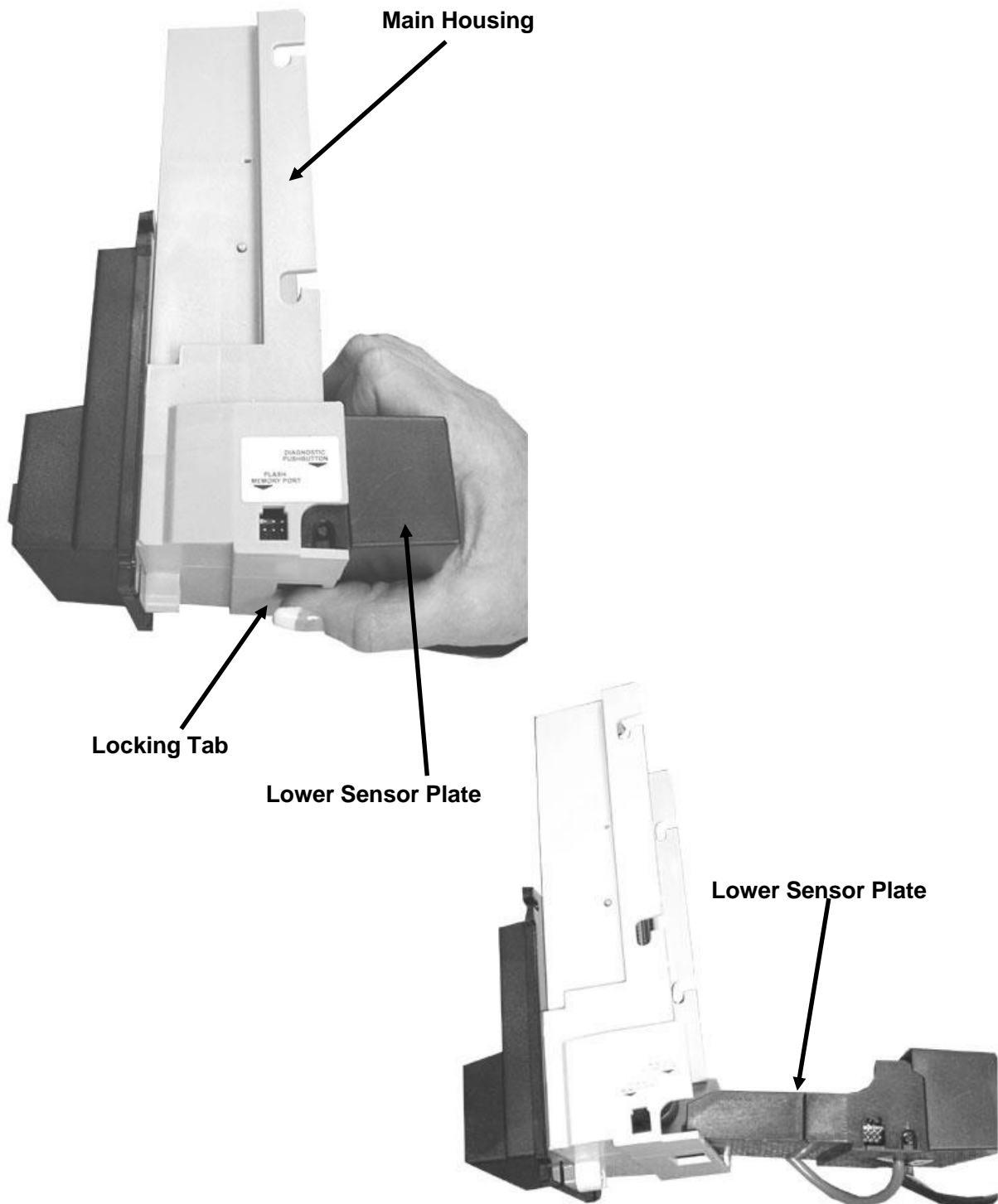

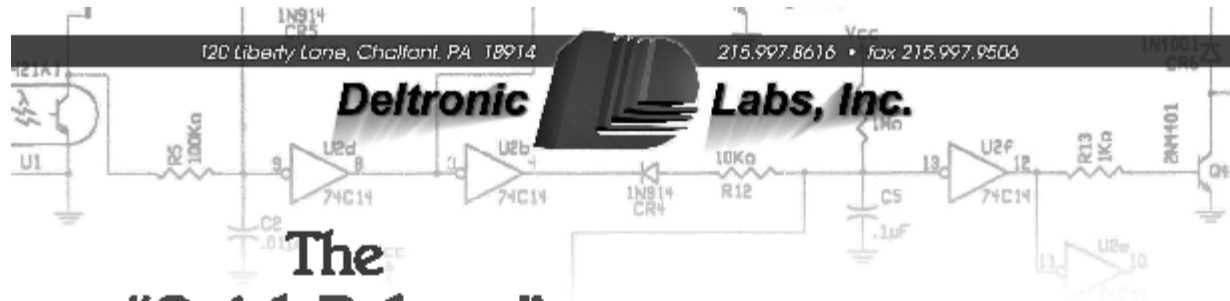

The "Quick Release" Ticket Dispenser Features All Models

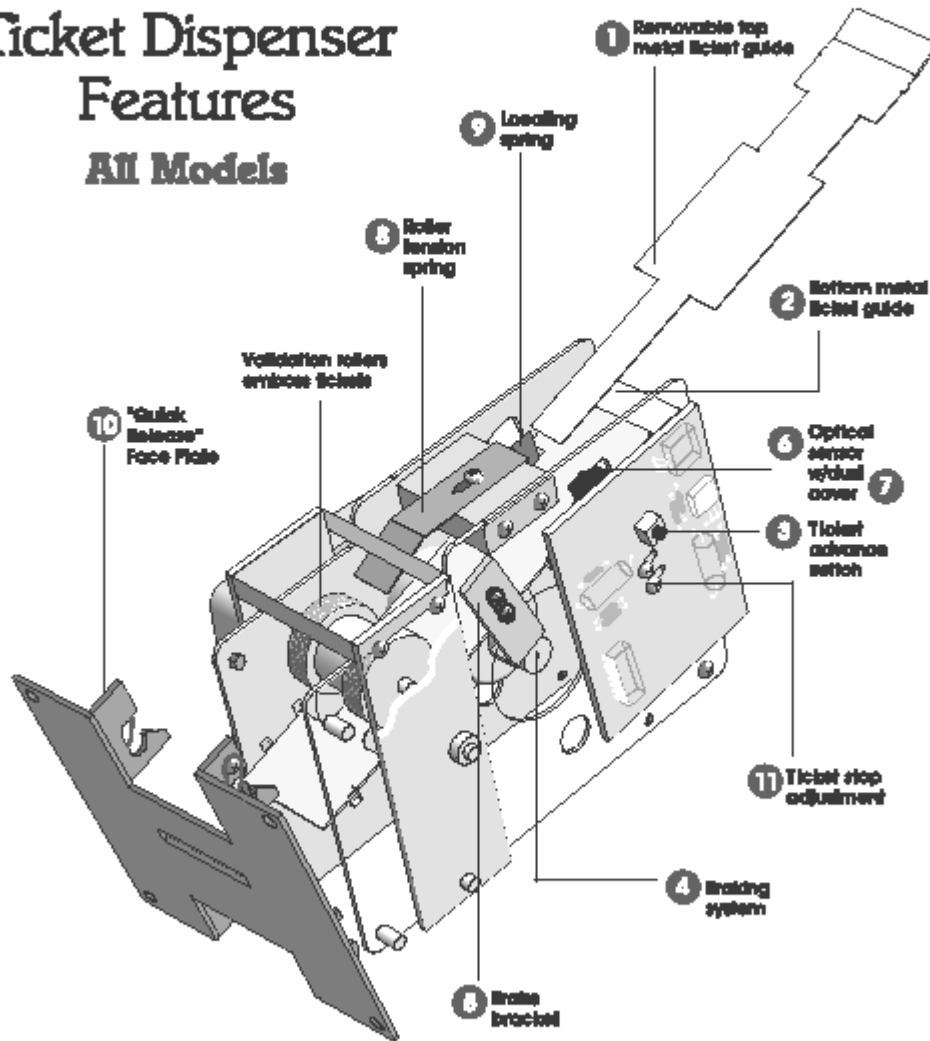

Quality Products from the Industry Leader in Ticket Dispensers

email: info@deltroniclabs.com • www.deltroniclabs.com

Deltronic Labs, Inc.

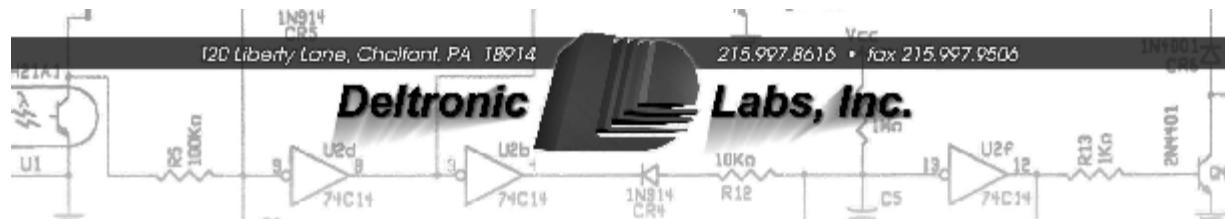

1. Top Metal Ticket Guide

For servicing, the top metal ticket guide can be removed and replaced. With unit facing you, gently spread side plates with thumb and index finger. Tilt guide to right at 45° angle and snap left side tab out and pull straight back. When replacing, simply reverse these steps. Note there is no need to spread side plates while replacing guide. Tilt to right and insert right tab first. Note: When PCB has opto-sensor cover, guide is inserted over sensor then directed down to right. Be sure guide is BELOW brake bracket screws when replaced.

2. Bottom Metal Ticket Guide

The longer, more durable ticket guide extends through the face plate allowing for better guidance plus a larger opening in the face plate prevents curled tickets from coloring.

3. Loading of tickets with ticket advance switch

Tickets are inserted in the rear of machine between the top and bottom ticket guides and pushed forward to the rollers. If needed, gently push the loading spring (9) away from the ticket guides. Then push the ticket advance switch until you see the edge of first ticket.

4. Braking system

Our impressive braking system eliminates brake slippage allowing foolproof, accurate dispensing. The design also reduces wear and tear on the dispenser.

5. Brake bracket

The brake is easily accessible and can be adjusted to engage immediately when ticket is pulled. (Minimum of 1/8" from brake wheel.)

6. Opto-Sensor

Included as part of the controller is an opto-electronic beam sensor which detects the notch between tickets. The output of the ticket sensing circuitry is an open collector transistor.

7. Opto-Sensor Dust Cover

In addition, an optical sensor dust cover is also included to eliminate the possibility of ticket dust accumulating on the optical sensor. This increases the accuracy of the ticket count and reduces maintenance.

8. Roller Tension Spring

The roller tension springs keep constant tension on tickets which insures proper delivery and prevents the tickets from being "pulled through" when the dispenser is idle. To increase the tension, loosen the screw and move the spring forward. Tension is correctly adjusted when tickets cannot be pulled from the dispenser and validation rollers lightly emboss the tickets.

9. Loading Spring

The ticket guide spring insures that the notches in the tickets pass through the opto-sensor. To decrease tension, loosen the screw and move the outer tension spring up. This changes the tension on the inner spring. The tickets should be snug between the spring and the side plate but not deformed by the excessive tension. The spring is adjusted at the factory for 1-5/32" wide tickets and positioned 1/8" from ticket guides.

10. "Quick Release" Face Plate

The dynamic design allows the ticket dispenser to "quickly release" from its face plate on your cabinet or ticket door. This can be done manually and no tools are needed. This gives you complete access to the front

of the rollers and to the ticket guides. Plus you can "snap out" one ticket dispenser and immediately replace it with another in just seconds.

11. Ticket Stop Adjustment

The ticket stop adjustment allows you to position the tickets while the machine is off. The tickets should protrude through the slot at least 1/16". The ticket dispenser PC board is mounted on spacer with two screws with washers in two slotted holes. Loosening the screws and moving the board forward will allow the tickets to stop further out beyond the edge of the slot.

Standard Dispenser Specifications

The quick release face plate greatly improves serviceability and reduces maintenance. Now standard on all Deltronic Labs Ticket Dispensers.



- Low voltage operations, only 12V DC
- Solid state output allows interfacing with electronic games
- Compact size, only 3 1/2" W x 4" H x 5 1/2" L
- Weight: 2 1/2 lbs.
- Validation "diamond" mark identifies tickets that have been dispensed.
- Adjustable ticket stop
- Dispenses 2" L x 1 1/2" W tickets
- 4" L x 2" W ticket
- 4" L x 1 1/2" W ticket
- 2" L x 2" W duplex ticket
- One year warranty
- Standard face plate: 4" H x 3 1/2" W
- Narrow face plate: 4" H x 3 1/4" W
- 12V meter output
- CE
- RoHS compliant

Quality Products from the Industry Leader in Ticket Dispensers

email: info@deltroniclabs.com • www.deltroniclabs.com

Deltronic Labs, Inc.

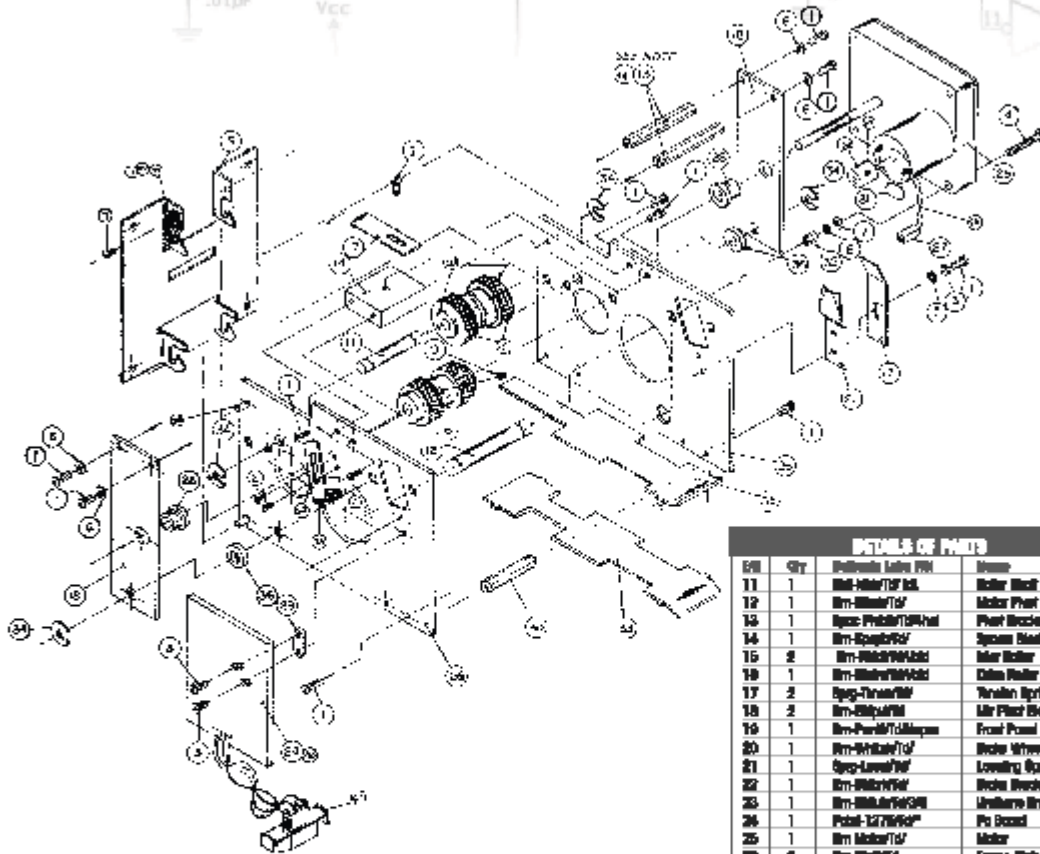
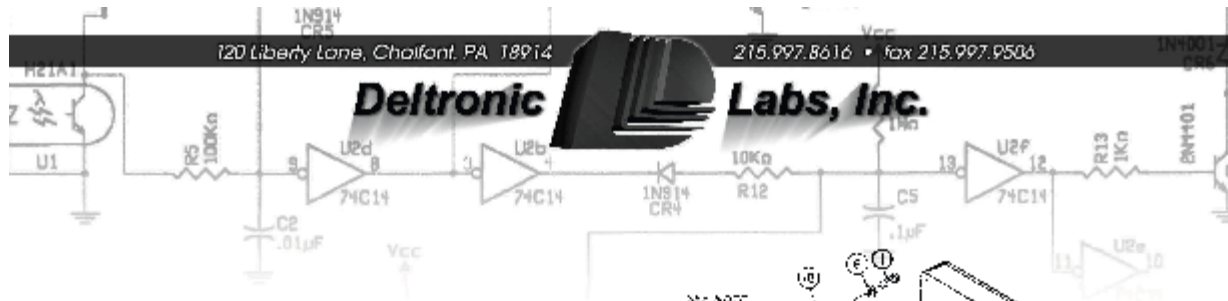

LIST OF PARTS

QTY	Part Name	Notes
11	Mt-Motor/TSP Idl	Motor Shell
12	Mt-Motor/TSP	Motor Print Shell
13	Spce-Pole/TSP/Idl	Print Bracket Spac
14	Mt-Scap/TSP	Spacer Block
15	Mt-Motor/TSP/Idl	Motor Roller
16	Mt-Motor/TSP/Idl	Drive Roller
17	Spag-Tense/Idl	Tension Spring
18	Mt-Strip/Idl	Mr Print Rst
19	Mt-Panel/TSP/Spce	Front Panel
20	Mt-Whisk/TSP	Wedge Wheel
21	Spag-Lever/Idl	Landing Guide
22	Mt-Motor/Idl	Wedge Bracket
23	Mt-Motor/Idl/Spce	Undersh Brake
24	Panel-12/TSP/Idl	Pt Board
25	Mt-Motor/Idl	Motor
26	Mt-Panel/Idl	Frame Plate
27	Mt-Carry/Idl/Spce	2-Pin Ferrule Conn.
28	Mtsp-R12/TSP/Spce	Shading
29	Spce-Pole/TSP/Idl	Roller Spacer
30	Spce-Head/TSP/Idl	Hex Spacer 1/2"
31	Mt-1/2/TSP/Idl	Lock Riv
32	Spce-Head/Idl	Shield Off
33	Roll-Deflect/Idl	Lower Guide Roll
34	Spag-Edge/Idl	Retaining Ring
35	Roll-Deflect/Idl	Top Guide Roll
36	Plate-Top/TSP/Idl	Spacer Washer
37	Spag-Front/Idl	Spring Front-Plate
38	Mt-Frame/Idl/Spce	Front Frame
39	Mt-Frame/Idl/Spce	Front Panel
40	Cover-Top/TSP/Idl	Case Cover
41	Clamp-Motor/Idl/Spce	4 Wire Motor Mt.
42	Mt-Label/Idl/Spce	Label Aluminum
43	Mt-Motor/Idl/Spce	
44	Spce-Pole/Idl/Spce	Spacer 1" Hex.

MATERIAL LIST FOR BOXING

QTY	Part Name	Description	
1	11	Mt-94-40/TSP/Idl	4-40x1" Screw
2	3	Mt-94-40/TSP/Idl	4-40 X 1/2" Washer Head
3	2	Mt-94-40/TSP/Idl	4-40 X 1/2" Washer Head
4	1	Mt-94/Idl	8-32 X 1/2"
5	1	Mt-94/Idl	84 Flat Washer
6	5	Mt-94/Idl	84 Split Lock Washer
7	2	Mt-94-40/TSP/Idl	Phillips Trenchhead
8	1	Mt-94/Idl	88 1/2" Str Washer
9	1	Case-Deflect	8-32 X 1/2" Roll Screw
10	1	Case-Deflect	8-32 X 1/2" Roll Screw

- * Order By Model Number
- ** MPTIS FPN #36 Replaces .032 And .036 Spacer Washers.
- *** MPTIS FPN #44 Replaces Logo Spacer Block.
- **** 88 1/2" Pins vary for 2" wide dispensers.

Quality Products from the Industry Leader in Ticket Dispensers

email: info@deltroniclabs.com • www.deltroniclabs.com

DPP-250 THERMAL PRINTER INSTRUCTIONS

***Note - A DPP-250 thermal printer user manual is included. Please review!**

TO PRINT A REPORT:

1. Open the cabinet door to access the control panel and the service button.
2. If the machine is not powered on, turn the power switch to the on position and wait for the vending mode to appear on the display. (see POWER-UP on pg.5)
3. Power on the thermal printer. Verify it is charged and ready to print.
4. Connect the small end of the provided USB cable to the handheld printer.
5. Connect the opposite end to the printer port found on the control bar.
6. Push the service button found on the back of the display. (see page 6)
7. The printer will automatically enter the Reports mode and print a report.

If the receipt did not print, power off the kiosk and go to step 2 above.

You will not need to power off or disconnect the printer to re-start the kiosk.

8. Exit the service mode on the front of the display.
9. Disconnect the USB cable from the printer and the control bar and power off the printer.